



01853E00

Control Station in Polyester Resin Series 8146

- Explosion protection to
 - CENELEC
 - IEC
- Can be used
 - in Zone 1 and Zone 2
 - in Zone 21 and Zone 22
- Enclosures in glass fibre reinforced polyester resin
- 7 basic enclosure sizes
- Different enclosure heights
- Options:
 - Flanges
 - Cover hinges
 - Flanged enclosure
 - Brass plates for metal cable entries
- Can be combined to larger units
- Equipped with built-in units for snap-in fitting
 - Control units
 - Indicating lamps
 - Illuminated buttons
 - Control switches
 - Ammeters
 - Voltmeters

Control, display and regulation devices are assembled in a clear layout in 8146 series control stations. The number of units fitted depends on the control station size and the space required to fit each device.

It is not possible to standardize this.

Zones 1 & 2, 21 & 22

Equipment table for control stations 8146, for units with contact spacing of 42 mm



09338E00

8082
Control unit with actuators \varnothing 38 mm

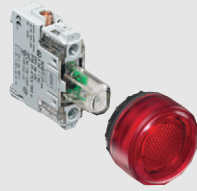

09339E00

8010
Indicating lamp

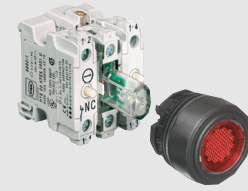

09340E00

8082/8010
Illuminated button

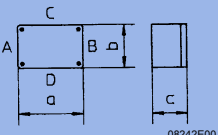
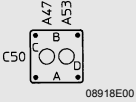
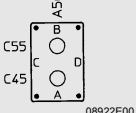
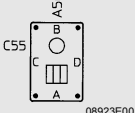
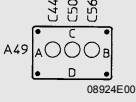
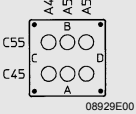
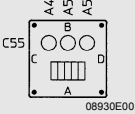
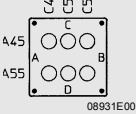
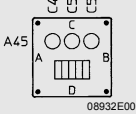
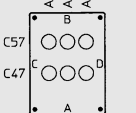
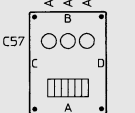
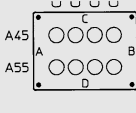
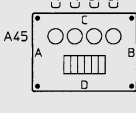
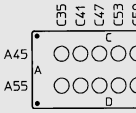
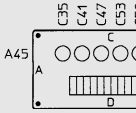
Enclosure	Equipment configuration	Ordering code	Weight (empty enclosure) [kg]						
 <p>Enclosure size 3</p> <p>Dimensions [mm]</p> <table border="1"> <tr><td>a</td><td>b</td><td>c</td></tr> <tr><td>112</td><td>112</td><td>91</td></tr> </table> <p>Side facing down</p>	a	b	c	112	112	91	<p>maximum options for built-in units with contact spacing of 42 mm; such as: control units 8082, indicating lamps 8010 and illuminated buttons 8082/8010</p> <p>Fig. 3.1</p> 	8146/5031-3.	0,64
a	b	c							
112	112	91							
<p>Enclosure size 4</p> <p>Dimensions [mm]</p> <table border="1"> <tr><td>a</td><td>b</td><td>c</td></tr> <tr><td>170</td><td>112</td><td>91</td></tr> </table> <p>Side facing down</p>	a	b	c	170	112	91	<p>Fig. 4.1</p>  <p>Fig. 4.2</p>  <p>Fig. 4.3</p> 	8146/5041-3.	0,70
a	b	c							
170	112	91							
<p>Enclosure size 5</p> <p>Dimensions [mm]</p> <table border="1"> <tr><td>a</td><td>b</td><td>c</td></tr> <tr><td>170</td><td>170</td><td>91</td></tr> </table> <p>Side facing down</p>	a	b	c	170	170	91	<p>Fig. 5.1</p>  <p>Fig. 5.2</p>  <p>Fig. 5.3</p>  <p>Fig. 5.4</p> 	8146/5051-3.	1,10
a	b	c							
170	170	91							
<p>Enclosure size 6</p> <p>Dimensions [mm]</p> <table border="1"> <tr><td>a</td><td>b</td><td>c</td></tr> <tr><td>227</td><td>170</td><td>91</td></tr> </table> <p>Side facing down</p>	a	b	c	227	170	91	<p>Fig. 6.1</p>  <p>Fig. 6.2</p>  <p>Fig. 6.3</p>  <p>Fig. 6.4</p> 	8146/5061-3.	1,40
a	b	c							
227	170	91							
<p>Enclosure size 7</p> <p>Dimensions [mm]</p> <table border="1"> <tr><td>a</td><td>b</td><td>c</td></tr> <tr><td>340</td><td>170</td><td>91</td></tr> </table> <p>Side facing down</p>	a	b	c	340	170	91	<p>Fig. 7.1</p>  <p>Fig. 7.2</p> 	8146/5071-3.	2,00
a	b	c							
340	170	91							
Add. to ordering code	Specify side facing down:	side A bottom (see above)	8146/ A						
		side D bottom (see above)	8146/ D						

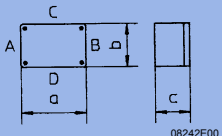
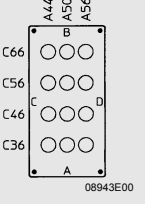
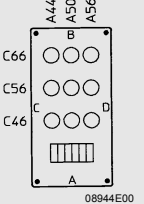
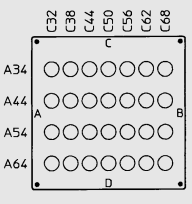
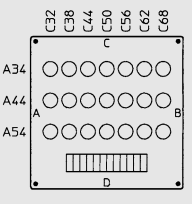
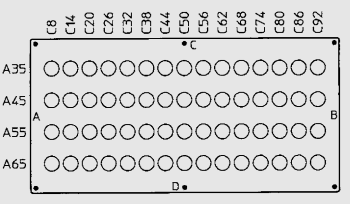
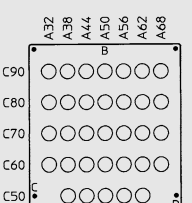
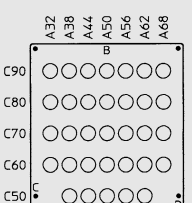

Enclosure		Equipment configuration maximum options for built-in units with contact spacing of 42 mm; such as: control units 8082, indicating lamps 8010 and illuminated buttons 8082/8010		Ordering code	Weight (empty enclosure) [kg]
					
Enclosure size 7	Dimensions [mm] a b c 340 170 91	Fig. 7.3 	Fig. 7.4 	8146/5071-3.	2,00
Side facing down		A	A		
Enclosure size 8	Dimensions [mm] a b c 340 340 91	Fig. 8.1 	Fig. 8.2 	8146/5081-3.	3,40
Side facing down		D	D		
Enclosure size 9	Dimensions [mm] a b c 680 340 91	Fig. 9.1 		8146/5091-3.	7,30
Side facing down		D			
Enclosure size 9	Dimensions [mm] a b c 680 340 91	Fig. 9.2 	Fig. 9.3 	8146/5091-3.	7,30
Side facing down		A	A		
Add. to ordering code		Specify side facing down:	side A bottom (see above)	8146 / A	
			side D bottom (see above)	8146 / D	



Equipment table for control stations 8146, for units with contact spacing of > 42 mm





Enclosure	Equipment configuration maximum options with built-in units with contact spacing > 42 mm; such as: control switches 8008, ammeters 8405, control units 8082 with actuators $\varnothing > 38$ mm	Ordering code	Weight (empty enclosure) [kg]
<p>Enclosure size 3</p> <p>Dimensions [mm] a b c 112 112 91</p> <p>Side facing down</p>	<p>Fig. 3.2 Fig. 3.3 Fig. 3.4</p> <p>D D D</p>	8146/5031-3.	0,64
<p>Enclosure size 4</p> <p>Dimensions [mm] a b c 170 112 91</p> <p>Side facing down</p>	<p>Fig. 4.4 Fig. 4.5 Fig. 4.6 Fig. 4.7</p> <p>A A D D</p>	8146/5041-3.	0,70
<p>Enclosure size 5</p> <p>Dimensions [mm] a b c 170 170 91</p> <p>Side facing down</p>	<p>Fig. 5.5 Fig. 5.6</p> <p>D D</p>	8146/5051-3.	1,10
<p>Enclosure size 6</p> <p>Dimensions [mm] a b c 227 170 91</p> <p>Side facing down</p>	<p>Fig. 6.5 Fig. 6.6</p> <p>A A</p>	8146/5061-3.	1,40
<p>Enclosure 7</p> <p>Dimensions [mm] a b c 340 170 91</p> <p>Side facing down</p>	<p>Fig. 7.5</p> <p>D</p>	8146/5071-3.	2,00
Add. to ordering code	Specify side facing down:	side A bottom (see above)	8146/A
		side D bottom (see above)	8146/D

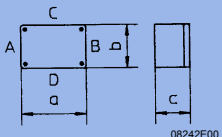
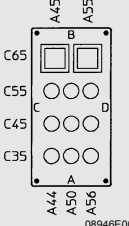
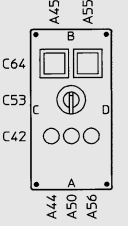
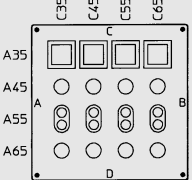
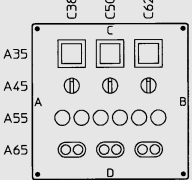
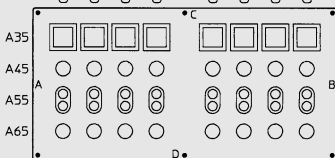
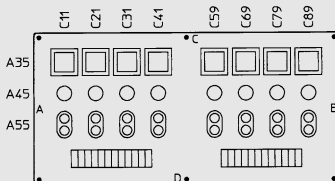



Enclosure		Equipment configuration maximum options with built-in units with contact spacing > 42 mm; such as: control switches 8008, ammeters 8405, control units 8082 with actuators $\varnothing > 38$ mm		Ordering code	Weight (empty enclosure) [kg]
					
Enclosure size 7	Dimensions [mm] a b c 340 170 91	Fig. 7.6 	Fig. 7.7 	8146/5071-3.	2,00
Side facing down		A	A		
Enclosure size 8	Dimensions [mm] a b c 340 340 91	Fig. 8.3 	Fig. 8.4 	8146/5081-3.	3,40
Side facing down		D	D		
Enclosure size 9	Dimensions [mm] a b c 680 340 91	Fig. 9.4 		8146/5091-3.	7,30
Side facing down		D			
Enclosure size 9	Dimensions [mm] a b c 680 340 91	Fig. 9.5 		8146/5091-3.	7,30
Side facing down		D			
Add. to ordering code		Specify side facing down:		8146/.....A	
		side A bottom (see above)		8146/.....D	
		side D bottom (see above)			

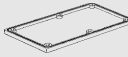

Technical Data	
Explosion protection	
Gas explosion protection	⊕ II 2 G EEx edmq ia / ib [ja / ib] IIA, IIB resp. IIC T6, T5 resp. T4
Dust explosion protection	⊕ II 2 D IP66 T80 °C, T95 °C, T130 °C
Certificates	
Gas explosion protection	PTB 01 ATEX 1024
Dust explosion protection	LCIE 02 ATEX 6241
Other certificates	CSA (Canada), UL (USA), UL do Brasil (Brazil) VNIIEF (Russia)
Material	
Housing	Polyester resin, glass fibre-reinforced, dark grey, similar to RAL 7024, impact strenght ≥ 7 Nm, surface resistance ≤ 10 ⁹ Ohm, material flame resistant, self-extinguishing
Gaskets	Polyurethane foam
Flanges	
Standard	the enclosures are supplied without flanges in the standard version
Special	the enclosures can be fitted on one or more sides with flanges; flange material: Polyester resin, glass fibre-reinforced
Cover fixing	
Standard	M 6, cheese-head screws with combined slot, captive, stainless steel
Special	with cover hinges
Rated working voltage	max. 1100 V
Connections	directly to component units or via terminal block
Degree of protection	IP 66 (dependent on components used)
Ambient temperature	- 20 °C ... + 40 °C

Accessories and spare parts						
Designation	Illustration	Description	Ordering code	Weight		
				kg		
Flange		Size 1	2,8 mm thick	8146001490	0,065	
		Size 1	5,8 mm thick	8146004490	0,106	
		can be mounted on enclosure	side			
			8146/.051; /.052	C/D		
			8146/.061; /.062	A/B/C/D		
			8146/.071; /.072	A/B/C/D		
			8146/.S71	C/D		
			8146/.081; /.082	A/B/C/D		
			8146/.091; /.092	A/B/C/D		
			Size 2	2,8 mm thick	8146005490	0,160
	Size 2		5,8 mm thick	8146006490	0,317	
			can be mounted on enclosure	Side		
			8146/.073; /.075	C/D		
			8146/.S73	C/D		
			8146/.083; /.085	A/B/C/D		
		8146/.086				
		8146/.093; /.095	A/B/C/D			
		Size 3	2,8 mm thick	8146010490	0,120	
Size 3		5,8 mm thick	8146011490	0,190		
		can be mounted on enclosure	Side			
		8146/.073 /.075	A/B			

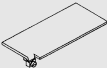

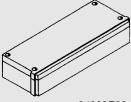
Accessories and spare parts						
Designation	Illustration	Description	Ordering code	Weight kg		
Brass plates 1mm	 04902E00	for flange size 1 (68 mm x 128 mm)	8146065550	0,040		
		for flange size 2 (126 mm x 266 mm)	8146075550	0,220		
		for flange size 3 (126 mm x 126 mm)	8146076550	0,120		
		8146/.031 8146/.041	C / D A / B	8146070550	0,040	
		8146/.041	C / D	8146071550	0,060	
		8146/.051 / .052 8146/.S71 / .S72	A / B A / B	8146066550	0,050	
		8146/.061 / .062	C / D	8146069550	0,080	
		8146/.071 / .072 8146/.081 / .082 8146/.091 / .092	C / D A / B C1 / D1	8146068550	0,140	
		8146/.073	A / B	8146081550	0,140	
		8146/.073 8146/.083 8146/.093	C / D A / B C1 / D1	8146082550	0,270	
		8146/.S71 / .S72 8146/.081 / .082 8146/.091 / .092	C / D C / D A / B	8146072550	0,160	
		8146/.S73	A / B	8146080550	0,100	
		8146/.S73 8146/.083 8146/.093	C / D C / D A / B	8146083550	0,310	
		8146/.091 / .092	C2 / D2	8146074550	0,160	
		8146/.093	C2 / D2	8146085550	0,310	
		for flange casing 8146		8146073550	0,120	
		Spacers	 04901E00	Size 0 (68 mm x 68 mm)	8146003100	0,010
				Size 1 (68 mm x 128 mm)	8146001100	0,020
				Size 2 (126 mm x 266 mm)	8146004100	0,040
				Size 3 (126 mm x 126 mm)	8146011100	0,100
Flange casing	 04900E00	with lid 2 mm thick	8146035040	0,661		
		with lid 5 mm thick	8146036040	0,850		
		can be mounted on enclosure enclosure side				
		8146/.071 8146/.081 8146/.091	C / D A / B / C / D A / B / C / D			

Dimension drawings (all dimensions in mm) - subject to alterations

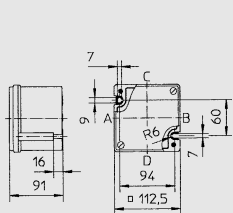

04180E00

8146/.03.

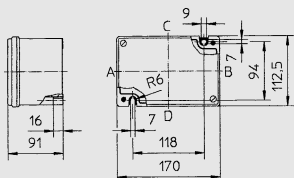

8146/.04.

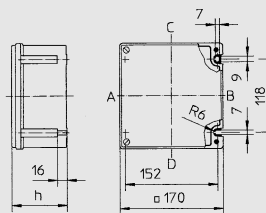

03179E00

8146/.05.

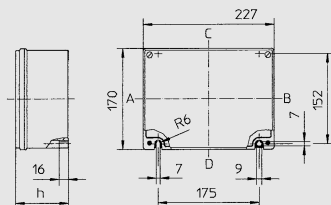

04304E00

8146/.06.

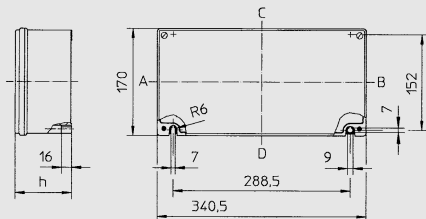

04305E00

8146/.07.

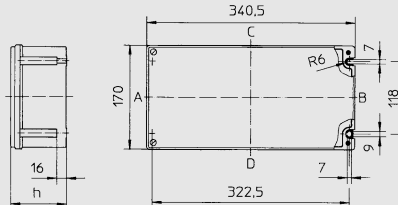

04306E00

8146/.S7.

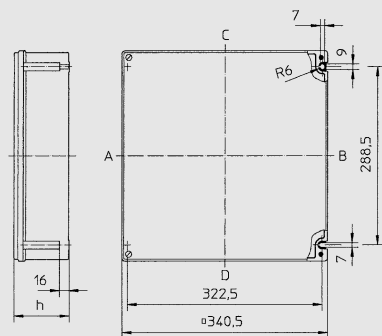

04307E00

8146/.08.

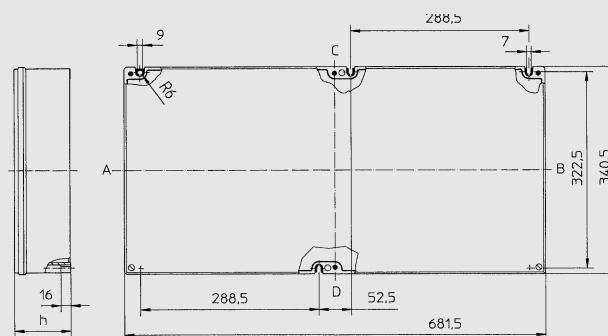

04308E00

8146/.09.

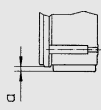

04309E00

Flange thickness [mm]	Dimension a [mm]
2,8	7
5,8	10

Additional dimensions for flange mounting

Enclosure	Height of enclosure h					
	8146/...1 91 mm	8146/...2 131 mm	8146/...3 150 mm	8146/...4 171 mm	8146/...5 190 mm	8146/...6 230 mm
8146/.03.	X	-	-	-	-	-
8146/.04.	X	-	-	-	-	-
8146/.05.	X	X	-	-	-	-
8146/.06.	X	X	-	-	-	-
8146/.07.	X	X	X	-	X	-
8146/.S7.	X	-	X	-	-	-
8146/.08.	X	X	X	X	X	X
8146/.09.	X	X	X	-	X	-

X ... can be supplied

We reserve the right to make alterations to the technical data, weights, dimensions, designs and products available without notice. The illustrations cannot be considered binding.

