



09965E00

Single-Channel Safety Barriers Series 9001

- Broad product range for all standard applications in the world of automation
- Flexible and space saving single and dual channel versions available
- Time saving installation due to
 - simple snap on DIN-Rail and
 - connection to PE and ground at the same time
- Reduced inventory due to uniform exchangeable fuse
- Installation possible in Zone 2 and Division 2

	Zones					
	0	1	2	20	21	22
Ex i Interfaces	X	X	X	X	X	X
Installation in			X			X

STAHl

R.STAHL safety barriers INTRINSPAK series 9001 are used for various applications in the arena of automation.

Based on the broad range of versions and the possibility of various interconnections it offers for almost all tasks.

The safety barriers enable the intrinsic safe operation of HART transmitter, proximity switches, potential-free contacts and temperature sensors, strain gauge, solenoid valves, indicators e.t.c.

The compact design allows a space saving and flexible installation in the cabinet. The mounting is very comfortable and easy due to the fact that installation on the DIN-rail and the contact to the potential equalization is made in one step.



Technical Data	
Certificates	<p>Europe (CENELEC) PTB 01 ATEX 2088 X</p> <p>IECEX IECEX PTB 09.0001X</p> <p>USA FM Approval 3011002 UL Approval E81680</p> <p>Canada CSA 1284547 (LR 43394)</p> <p>Russia GOST R CTB 04.B00764</p> <p>Ukraine ISCVE</p> <p>Belarus Gospromnadzor</p> <p>Kazakhstan JSC</p>
Explosion protection	<p>Europe (CENELEC) ⊕ II 3 (1) G Ex nA [ia Ga] IIC/IIB T4 Gc ⊕ II (1) D [Ex ia Da] IIIC</p> <p>USA I.S. circuits for: Class I, II, III, Division 1, Groups A, B, C, D, E, F, G I.S. circuits for: Class I, Zone 0, Group IIC Class I, Division 2, Groups A, B, C, D Class I, Zone 2, Group IIC</p> <p>Canada I.S. circuits for: Class I, Groups A, B, C, D; Class II, Groups E, F, G; Class III Class I, Division 2, Groups A, B, C, D Class I, Zone 2, Group IIC</p>
Installation	in Zone 2, Division 2 and in safe area
Enclosure material	Polyamide 6 GF
Type of protection	according to IEC 60529
	terminal enclosure: IP20 housing: IP40
Connection	4 cage terminals, each maximum 1.5 mm ² flexible / solid 2 PA-terminals, each maximum 4 mm ² flexible / solid
Ambient temperature	- 20 ... + 60 °C
Storage	- 20 ... + 75 °C
Maximum relative humidity	95 % mean, no dewing
Leakage current at U _N	≤ 2 μA (if not stated otherwise)
Temperature effect	≤ 0.25 % / 10 K
Frequency	at resistive current limitation: at I _m ≤ 50 mA ≤ 50 kHz at I _m > 50 mA ≤ 100 kHz at electronic current limitation: ≤ 10 k [^] Hz
Weight	approx. 0.115 kg

Selection Table

Version	Description	Type	Page
Single-channel barriers	<ul style="list-style-type: none"> • Grounded circuit • Current limitation to < 100 mA 	9001/01	4
	<ul style="list-style-type: none"> • Grounded circuit • Allows the connection of regulated power supplies, U_N 	9001/01	5
	<ul style="list-style-type: none"> • Application specific for the connection of volt free contacts • Operational current limited to < 40 mA • Grounded circuit • Allows the connection of unregulated power supplies, U_N between + 20 to 35 V DC 	9001/01	6
	<ul style="list-style-type: none"> • Application specific for the connection of volt free contacts • Operational current limited < 40 mA • Grounded field device • Allows the connection of unregulated power supplies, U_N between + 20 to 35 V DC 	9001/01	7
	<ul style="list-style-type: none"> • Application specific for the connection of solenoid valves, LEDs or audible alarms • Grounded circuit • Allows the connection of unregulated power supplies, U_N between + 20 to 35 V DC 	9001/01	8
	<ul style="list-style-type: none"> • Grounded circuit • Allows the connection of regulated power supplies, U_N 	9001/00	9
	<ul style="list-style-type: none"> • Grounded circuit • Suitable for AC and DC circuits 	9001/02	10
	<ul style="list-style-type: none"> • Grounded circuit • Suitable for AC and DC circuits • Current limitation to < I_{max} 	9001/02	11
	<ul style="list-style-type: none"> • Grounded circuit • For DC current signal returns • Current limitation to < I_{max} 	9001/03	12
	<ul style="list-style-type: none"> • Application specific for HART transmitters • Grounded field device • Allows the connection of unregulated power supplies, U_N between + 20 to 35 V DC 	9001/51	13
	<ul style="list-style-type: none"> • Application specific for transmitters • Grounded field device • Allows the connection of unregulated power supplies, U_N between + 20 to 35 V DC 	9001/51	14

Single-Channel Safety Barriers for Positive Polarity

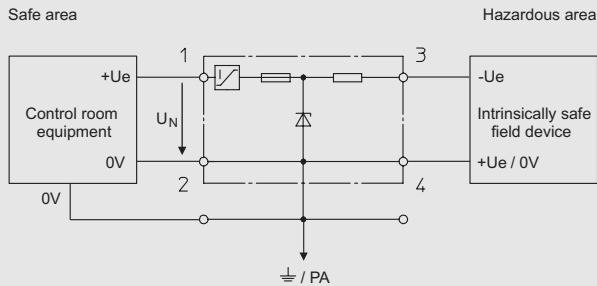

- Grounded circuit
- Current limitation to < 100 mA
- Approved for installation in Division 2 and Zone 2

05495E02

Selection Table

U _N	R _{min}	R _{max}	I _{max}	ΔU	Safety values								Order number
					U _o	I _o	P _o	IIC		IIB			
V	Ω	Ω	mA	V	V	mA	mW	L _o mH	C _o μF	L _o mH	C _o μF		
12	64	73	< 100	< 1.4	15.8	270	1067	0.23	0.478	2.2	2.88	9001/01-158-270-101	
12	46	53	< 100	< 1.4	15.8	390	1541	0.16	0.478	0.89	2.88	9001/01-158-390-101	
16	57	66	< 100	< 1.4	19.9	390	1940	--	--	0.89	1.42	9001/01-199-390-101	
24	111	124	< 100	< 1.4	28	280	1960	--	--	0.6	0.65	9001/01-280-280-101 *)	

*) Ambient temperature - 20 ... + 50 °C

Functional and Maximum Safety Values

U _N	Nominal voltage	ΔU	Additional voltage drop through the safety barrier	L _o	Maximum permissible external inductance
R _{min}	Minimum resistance of the safety barrier	U _o	Maximum voltage	C _o	Maximum permissible external capacity
R _{max}	Maximum resistance of the safety barrier	I _o	Maximum current		
I _{max}	Maximum current through the safety barrier	P _o	Maximum power		



Single-Channel Safety Barriers for Positive Polarity

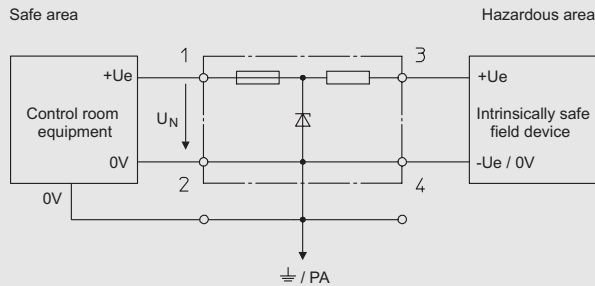

- Grounded circuit
- Allows the connection of regulated power supplies, U_N
- Approved for installation in Division 2 and Zone 2

05438E02

Selection Table

U_N	R_{min}	R_{max}	I_{max}	Safety values								Order number
				U_o	I_o	P_o	IIC L_o	C_o	IIB L_o	C_o		
V	Ω	Ω	mA	V	mA	mW	mH	μF	mH	μF		
1 ... 3	42	49	61	5	150	187.5	1.3	100	7	1000	9001/01-050-150-101	
6	24	27	222	8.3	442	917.2	0.1	7.2	0.5	73	9001/01-083-442-101	
6	864	963	6	8.6	10	21.5	300	6.2	1000	55	9001/01-086-010-101	
6	452	501	11	8.6	20	43	90	6.2	330	55	9001/01-086-020-101	
6	195	218	27	8.6	50	107.5	15	6.2	56	55	9001/01-086-050-101	
6	129	144	41	8.6	75	161.3	6.7	6.2	25	55	9001/01-086-075-101	
6	64	73	82	8.6	150	322.5	1.3	6.2	7	55	9001/01-086-150-101	
6	39	44	136	8.6	270	580.5	0.23	6.2	2.2	55	9001/01-086-270-101	
6	27	32	187	8.6	390	839	0.16	6.2	1	55	9001/01-086-390-101	
8	681	698	11	12.6	20	63	90	1.15	330	7.4	9001/01-126-020-101	
8	263	294	27	12.6	50	158	15	1.15	56	7.4	9001/01-126-050-101	
8	178	199	40	12.6	75	236	6.7	1.15	25	7.4	9001/01-126-075-101	
8	93	106	75	12.6	150	473	1.3	1.15	7	7.4	9001/01-126-150-101	
10	215	240	41	13.7	65	222.6	8.8	0.79	34	5	9001/01-137-065-101	
12	120	135	88	15.8	150	593	1	0.478	7	2.88	9001/01-158-150-101	
12	872	965	12	16.8	20	84	90	0.39	330	2.29	9001/01-168-020-101	
12	377	420	28	16.8	50	210	15	0.39	56	2.29	9001/01-168-050-101	
12	235	262	45	16.8	75	315	7	0.39	25	2.29	9001/01-168-075-101	
16	2096	2321	6	19.9	10	50	330	0.223	1000	1.42	9001/01-199-010-101	
16	1052	1165	13	19.9	20	100	90	0.223	330	1.42	9001/01-199-020-101	
16	539	598	26	19.9	38	189	26	0.223	95	1.42	9001/01-199-038-101	
16	415	462	34	19.9	50	249	15	0.223	56	1.42	9001/01-199-050-101	
16	282	241	66	19.9	100	498	4	0.223	15	1.42	9001/01-199-100-101	
16	149	168	95	19.9	150	746	1.3	0.223	7	1.42	9001/01-199-150-101	
20	378	421	47	25.2	70	441	4.5	0.107	25	0.82	9001/01-252-070-101	
24	1435	1590	15	28	20	140	50	0.083	50	0.65	9001/01-280-020-101	
24	599	666	36	28	50	350	8.5	0.083	25	0.65	9001/01-280-050-101	
24	415	462	51	28	75	525	3.3	0.083	21	0.65	9001/01-280-075-101	
24	340	375	64	28	85	595	2.4	0.083	16	0.65	9001/01-280-085-101	
24	286	319	75	28	100	700	1.6	0.083	11	0.65	9001/01-280-100-101	
24	263	294	81	28	110	770	1.2	0.083	9	0.65	9001/01-280-110-101	
24	177	198	121	28	165	1155	--	--	3.5	0.65	9001/01-280-165-101	

Note Application example see General - Standard Applications

Functional and Maximum Safety Values

U_N	Nominal voltage	I_{max}	Maximum current through the safety barrier	P_o	Maximum power
R_{min}	Minimum resistance of the safety barrier	U_o	Maximum voltage	L_o	Maximum permissible external inductance
R_{max}	Maximum resistance of the safety barrier	I_o	Maximum current	C_o	Maximum permissible external capacity

Single-Channel Safety Barriers for Positive Polarity

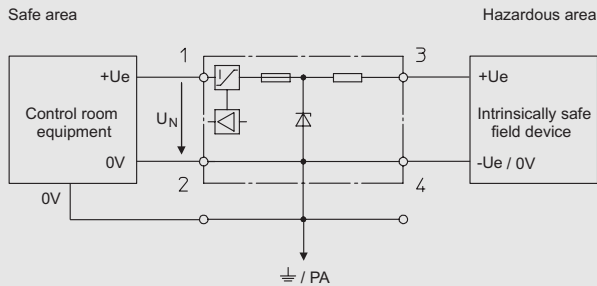

- Application specific for the connection of volt free contacts
- Operational current limited to < 40 mA
- Grounded circuit
- Allows the connection of unregulated power supplies, U_N between + 20 to 35 V DC
- Approved for installation in Division 2 and Zone 2

05494E02

Selection Table

U_N	R_{min}	R_{max}	I_{max}	Safety values						Order number	
				U_o	I_o	P_o	IIC L_o	C_o	IIB L_o		C_o
V	Ω	Ω	mA	V	mA	mW	mH	μF	mH	μF	
20 ... 35	454	505	40	25.2	57	359	6.3	0.107	25	0.82	9001/01-252-057-141 *)

*) Maximum leakage (terminal 1 -> PA/PE) $I_{leak} \leq 100 \mu A$

Functional and Maximum Safety Values

U_N	Nominal voltage	I_{max}	Maximum current through the safety barrier	P_o	Maximum power
R_{min}	Minimum resistance of the safety barrier	U_o	Maximum voltage	L_o	Maximum permissible external inductance
R_{max}	Maximum resistance of the safety barrier	I_o	Maximum current	C_o	Maximum permissible external capacity



Single-Channel Safety Barriers for Positive Polarity

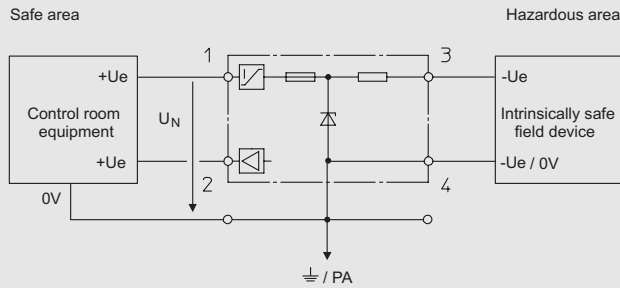

- Application specific for the connection of volt free contacts
- Operational current limited < 40 mA
- Grounded field device
- Allows the connection of unregulated power supplies, U_N between + 20 to 35 V DC
- Approved for installation in Division 2 and Zone 2

05440E02

Selection Table

U_N	R_{min}	R_{max}	I_{max}	Safety values								Order number
				U_o	I_o	P_o	IIC L_o	C_o	IIB L_o	C_o		
V	Ω	Ω	mA	V	mA	mW	mH	μF	mH	μF		
20 ... 35	454	505	40	25.2	60	378	6.2	0.107	25	0.82	9001/01-252-060-141 *)	

*) Maximum leakage (terminal 1 -> PA/PE) $I_{leak} \leq 100 \mu A$

Functional and Maximum Safety Values

U_N	Nominal voltage	I_{max}	Maximum current through the safety barrier	P_o	Maximum power
R_{min}	Minimum resistance of the safety barrier	U_o	Maximum voltage	L_o	Maximum permissible external inductance
R_{max}	Maximum resistance of the safety barrier	I_o	Maximum current	C_o	Maximum permissible external capacity

Single-Channel Safety Barriers for Positive Polarity

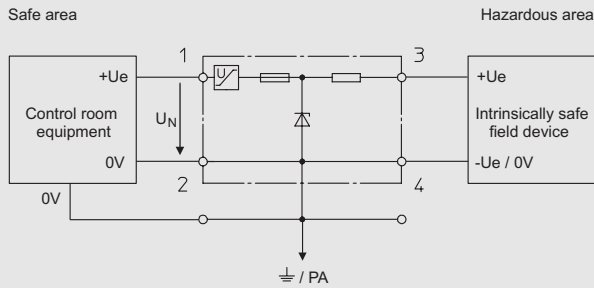

- Application specific for the connection of solenoid valves, LEDs or audible alarms
- Grounded circuit
- Allows the connection of unregulated power supplies, U_N between + 20 to 35 V DC
- Approved for installation in Division 2 and Zone 2

05501E02

Selection Table

U_N	R_{min}	R_{max}	I_{max}	Safety values							Order number
				U_o	I_o	P_o	IIC L_o	C_o	IIB L_o	C_o	
V	Ω	Ω	mA	V	mA	mW	mH	μF	mH	μF	
20 ... 35	259	268	78	25.2	100	630	2	0.107	11	0.82	9001/01-252-100-141 *)

*) Maximum leakage (terminal 1 -> PA/⊥) $I_{leak} \leq 1 \text{ mA} / 10 \text{ mA}$ at 24 V / 35 V

Functional and Maximum Safety Values

U_N	Nominal voltage	I_{max}	Maximum current through the safety barrier	P_o	Maximum power
R_{min}	Minimum resistance of the safety barrier	U_o	Maximum voltage	L_o	Maximum permissible external inductance
R_{max}	Maximum resistance of the safety barrier	I_o	Maximum current	C_o	Maximum permissible external capacity



Single-Channel Safety Barriers for Negative Polarity

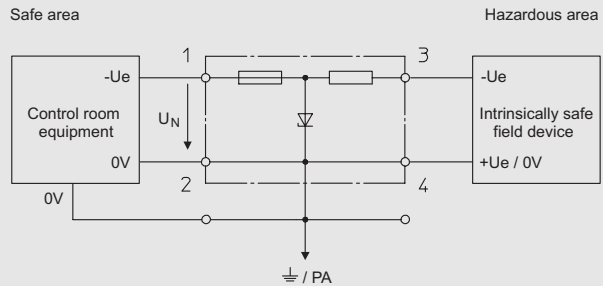

- Grounded circuit
- Allows the connection of regulated power supplies, U_N
- Approved for installation in Division 2 and Zone 2

05428E02

Selection Table

U_N	R_{min}	R_{max}	I_{max}	Safety values								Order number
				U_o	I_o	P_o	IIC L_o	C_o	IIB L_o	C_o		
V	Ω	Ω	mA	V	mA	mW	mH	μF	mH	μF		
1 ... 3	42	49	61	5	150	187.5	1.3	100	7	1000	9001/00-050-150-101	
6	24	28	214	8.3	442	917.2	0.1	7.2	0.5	73	9001/00-083-442-101	
6	864	963	6	8.6	10	21.5	300	6.2	1000	55	9001/00-086-010-101	
6	452	501	11	8.6	20	43	90	6.2	330	55	9001/00-086-020-101	
6	195	218	27	8.6	50	107.5	15	6.2	56	55	9001/00-086-050-101	
6	92	103	58	8.6	100	215	4	6.2	15	55	9001/00-086-100-101	
6	64	73	82	8.6	150	322.5	1.3	6.2	7	55	9001/00-086-150-101	
6	27	32	187	8.6	390	839	0.16	6.2	1	55	9001/00-086-390-101	
10	215	240	41	13.7	65	222.6	8.8	0.79	34	5	9001/00-137-065-101	
12	120	135	88	15.8	150	593	1	0.478	7	2.88	9001/00-158-150-101	
16	2096	2321	6	19.9	10	50	330	0.223	1000	1.42	9001/00-199-010-101	
16	1052	1165	13	19.9	20	100	90	0.223	330	1.42	9001/00-199-020-101	
16	539	598	26	19.9	38	189	26	0.223	95	1.42	9001/00-199-038-101	
16	149	168	95	19.9	150	746	1.3	0.223	7	1.42	9001/00-199-150-101	
24	599	666	36	28	50	350	8.5	0.083	25	0.65	9001/00-280-050-101	
24	1435	1590	15	28	20	140	50	0.083	50	0.65	9001/00-280-020-101	
24	340	375	64	28	85	595	2.4	0.083	16	0.65	9001/00-280-085-101	
24	286	319	75	28	100	700	1.6	0.083	11	0.65	9001/00-280-100-101	
24	263	294	81	28	110	770	1.2	0.083	9	0.65	9001/00-280-110-101	
24	177	198	121	28	165	1155	--	--	3.5	0.65	9001/00-280-165-101	

Functional and Maximum Safety Values

U_N	Nominal voltage	I_{max}	Maximum current through the safety barrier	P_o	Maximum power
R_{min}	Minimum resistance of the safety barrier	U_o	Maximum voltage	L_o	Maximum permissible external inductance
R_{max}	Maximum resistance of the safety barrier	I_o	Maximum current	C_o	Maximum permissible external capacity



Single-Channel Safety Barriers for Alternating Polarity

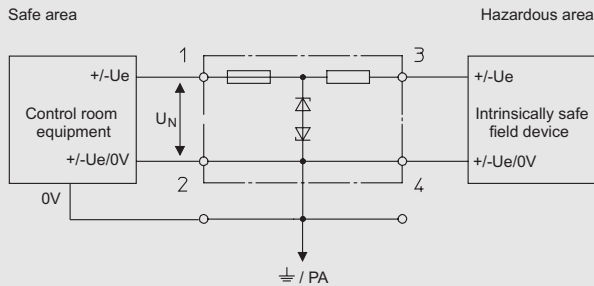

- Grounded circuit
- Suitable for AC and DC circuits
- Approved for installation in Division 2 and Zone 2

05502E02

Selection Table

U _N	R _{min}	R _{max}	I _{max}	Safety values								Order number
				U _o	I _o	P _o	IIC		IIB			
V	Ω	Ω	mA	V	mA	mW	L _o	C _o	L _o	C _o		
				V	mA	mW	mH	μF	mH	μF		
0.7	119	134	5	1.6	15	6	160	100	560	1000	9001/02-016-015-101 *)	
0.7	38	43	16	1.6	50	20	15	100	56	1000	9001/02-016-050-101 *)	
0.7	39	40	17	1.6	50	20	15	100	56	1000	9001/02-016-050-111 *)	
0.7	--	20	35	1.6	150	60	1.3	100	7	1000	9001/02-016-150-101 *)	
0.7	19	20	35	1.6	150	60	1.3	100	7	1000	9001/02-016-150-111 *)	
0.7	11	14	50	1.6	320	128	0.19	100	1.6	1000	9001/02-016-320-101 *)	
6	3141	3472	1,7	9.3	3	6.975	1000	4.1	1000	31	9001/02-093-003-101	
6	319	354	16	9.3	30	69.8	40	4.1	150	31	9001/02-093-030-101	
6	195	218	27	9.3	50	116.3	15	4.1	56	31	9001/02-093-050-101	
6	148	165	36	9.3	75	174.4	6.7	4.1	25	31	9001/02-093-075-101	
6	70	79	75	9.3	150	348.8	1.3	4.1	7	31	9001/02-093-150-101	
6	--	36	166	9.3	390	906.8	0.16	4.1	0.89	31	9001/02-093-390-101	
10	102	115	86	13.3	150	498.8	1.3	0.91	7	5.6	9001/02-133-150-101	
12	378	421	28	17.5	50	219	15	0.339	56	1.97	9001/02-175-050-101	
12	197	222	54	17.5	100	437.5	4	0.339	15	1.97	9001/02-175-100-101	
12	101	114	105	17.5	200	875	0.5	0.339	4	1.97	9001/02-175-200-101	
16	148	167	95	19.6	150	735	1.3	0.235	7	1.47	9001/02-196-150-101	
24	320	357	67	28	90	630	2.2	0.083	14	0.65	9001/02-280-090-101	
36	456	509	70	41.2	95	979	--	--	9	0.287	9001/02-412-095-101	

*) Maximum leakage Tolerance I_{leak} ≤ 10 μA ± 0.5 %

Note Application example see General - Standard Applications

Functional and Maximum Safety Values

U _N	Nominal voltage	I _{max}	Maximum current through the safety barrier	P _o	Maximum power
R _{min}	Minimum resistance of the safety barrier	U _o	Maximum voltage	L _o	Maximum permissible external inductance
R _{max}	Maximum resistance of the safety barrier	I _o	Maximum current	C _o	Maximum permissible external capacity



Single-Channel Safety Barriers for Alternating Polarity

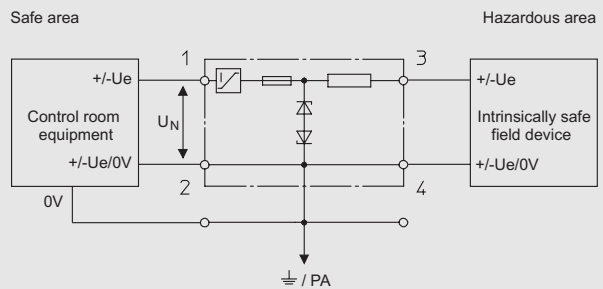

- Grounded circuit
- Suitable for AC and DC circuits
- Current limitation to $< I_{max}$
- Approved for installation in Division 2 and Zone 2

Selection Table

U_N	R_{min}	R_{max}	I_{max}	ΔU	Safety values								Order number
					U_o	I_o	P_o	IIC L_o	C_o	IIB L_o	C_o		
V	Ω	Ω	mA	V	V	mA	mW	mH	μF	mH	μF		
16	63	72	< 80	< 1.4	21.7	390	2116	--	--	0.89	1.17	9001/02-217-390-101	
24	143	162	< 65	< 1.4	30.8	230	1771	--	--	0.7	0.524	9001/02-308-230-101	

Functional and Maximum Safety Values

U_N	Nominal voltage	I_{max}	Maximum current through the safety barrier	P_o	Maximum power
R_{min}	Minimum resistance of the safety barrier	U_o	Maximum voltage	L_o	Maximum permissible external inductance
R_{max}	Maximum resistance of the safety barrier	I_o	Maximum current	C_o	Maximum permissible external capacity

Single-Channel Diode Return Barriers for Positive Polarity

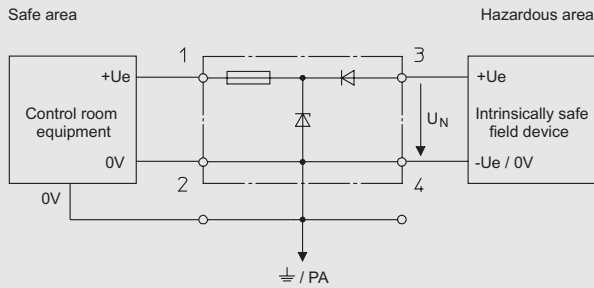

- Grounded circuit
- For DC current signal returns
- Current limitation to $< I_{max}$
- Approved for installation in Division 2 and Zone 2

05541E02

Selection Table

U _N	I _{max}	ΔU	Safety values							Order number
			U _o	I _o	P _o	IIC	IIB	C _o		
V	mA	V	V	mA	mW	L _o mH	C _o μF	L _o mH	C _o μF	
6	< 150	3.5	8.6	0	0	1000	6.2	1000	55	9001/03-086-000-101 *)
12	< 100	3.5	16.8	0	0	1000	0.39	1000	2.29	9001/03-168-000-101 *)
16	< 100	3.5	19.9	0	0	1000	0.223	1000	1.42	9001/03-199-000-101 *)
24	< 100	3.5	28	0	0	50	0.083	50	0.65	9001/03-280-000-101 **)

*) Short circuit rating not short circuit proof

**) Ambient temperature - 20 ... + 50 °C

Functional and Maximum Safety Values

U _N	Nominal voltage	U _o	Maximum voltage	L _o	Maximum permissible external inductance
I _{max}	Maximum current through the safety barrier	I _o	Maximum current	C _o	Maximum permissible external capacity
ΔU	Additional voltage drop through the safety barrier	P _o	Maximum power		



Single-Channel Safety Barriers for Transmitters

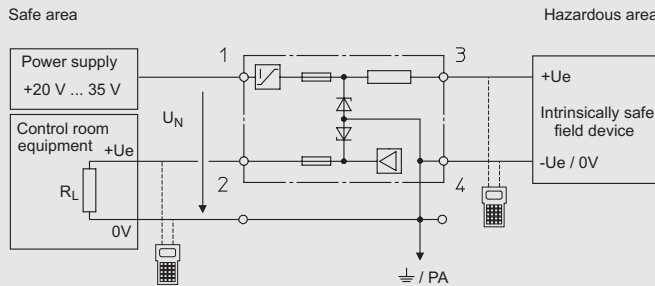

05561E02

- Application specific for HART transmitters
- Grounded field device
- Allows the connection of unregulated power supplies, U_N between + 20 to 35 V DC
- Approved for installation in Division 2 and Zone 2

Selection Table

U_N	Safety values							Order number
	U_o	I_o	P_o	IIC		IIB		
V	V	mA	mW	L_o	C_o	L_o	C_o	
				mH	μF	mH	μF	
20 ... 35	28	110	770	1.2	0.083	9	0.65	9001/51-280-110-141

Technical Data

Supply current	$I_s \leq 50$ mA
Accuracy	± 0.05 %
Temperature effect	± 0.1 % / 10 K
Longterm drift	± 0.05 %
Rated operational current	$I_N = 3.6$ mA ... 22 mA
Load	$R_L \leq 500 \Omega$ ($U_N \leq 23.5$ V) $R_L \leq 750 \Omega$ ($U_N > 23.5$ V)
Transmitter supply voltage	U_{min} ($I_N = 20$ mA) U_N $U_N - 8.5$ V ≤ 23.5 V 15 V > 23.5 V

Note Application example see General - Standard Applications

Functional and Maximum Safety Values

U_N	Nominal voltage	P_o	Maximum power		
U_o	Maximum voltage	L_o	Maximum permissible external inductance		
I_o	Maximum current	C_o	Maximum permissible external capacity		



Single-Channel Safety Barriers for Transmitter

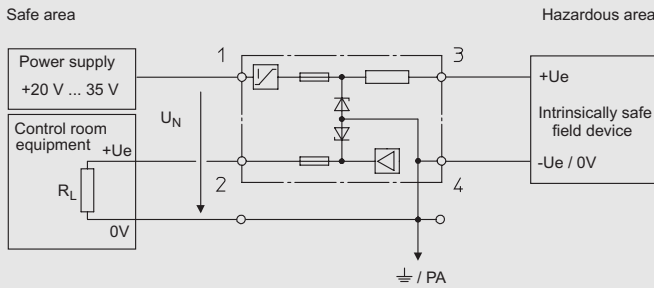

- Application specific for transmitters
- Grounded field device
- Allows the connection of unregulated power supplies, U_N between + 20 to 35 V DC
- Approved for installation in Division 2 and Zone 2

Selection Table

U_N	Safety values							Order number
	U_o	I_o	P_o	IIC	C_o	IIB	C_o	
V	V	mA	mW	L_o mH	C_o μF	L_o mH	C_o μF	
20 ... 35	28	91	637	2.2	0.083	14	0.65	9001/51-280-091-141

Technical Data







Supply current	$I_s \leq 50 \text{ mA}$	
Accuracy	$\pm 0.05 \%$	
Temperature effect	$\pm 0.1 \%$ / 10 K	
Longterm drift	$\pm 0.05 \%$	
Rated operational current	$I_N = 3.6 \text{ mA} \dots 22 \text{ mA}$	
Load	$R_L \leq 350 \Omega$	
Transmitter supply voltage	$U_{min} (I_N = 20 \text{ mA})$ $U_N - 9.5 \text{ V}$ 14 V	U_N $\leq 23.5 \text{ V}$ $> 23.5 \text{ V}$

Note Application example see General - Standard Applications

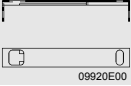
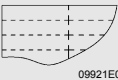
Functional and Maximum Safety Values

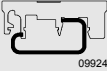
U_N	Nominal voltage	P_o	Maximum power		
U_o	Maximum voltage	L_o	Maximum permissible external inductance		
I_o	Maximum current	C_o	Maximum permissible external capacity		

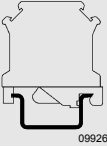
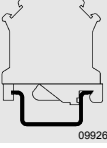

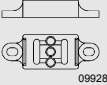
Accessories and Spare Parts				
Designation	Illustration	Description	Order number	Weight kg
Back-up fuse	 09919E00	for all safety barriers Series 9001, 9002 and 9004 unit: 5 pcs.	158964	0.008
Holder for labels	 09920E00		158977	0.002
Labelling paper	 09921E00	perforated, for typing Format: DIN A4	158973	0.005
Adaptor	 09922E00		158826	0.006
Mounting attachment moulded plastic	 09924E00		165283	0.004
DIN rail	 07104E00	NS 35 / 15 (meter length)	103714	1.410
Earth terminal	 09926E00	USLKG 5 (wire range $\leq 4 \text{ mm}^2$)	112760	0.012
Earth terminal	 09926E00	USLKG 6 N (wire range $\leq 6 \text{ mm}^2$)	112599	0.030
Fuse holder	 09927E00		158834	0.020
Insulating stand off	 09928E00	for rail NS 35/15	158828	0.023

Dimensional Drawings (All Dimensions in mm) - Subject to Alterations

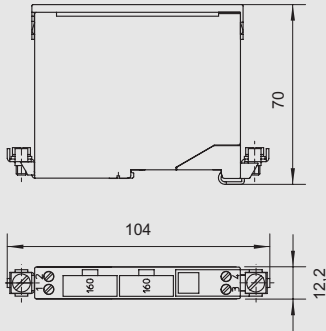

09929E00

Safety barriers 9001, 9002, 9004

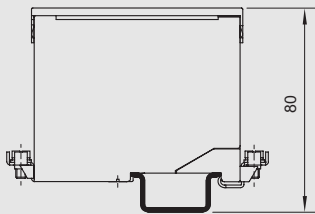

09930E00

Safety barriers 9001, 9002, 9004
mounting on
DIN rail NS 35/15 (acc. to EN 50 022)

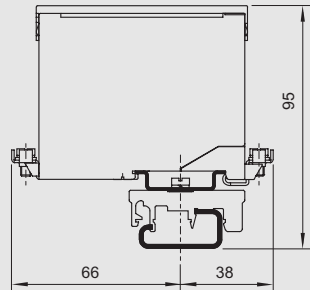

09932E00

Safety barriers 9001, 9002, 9004
mounting on
DIN rail NS 32 (acc. to EN 50 035)
by means of adaptor and
mounting attachment, moulded plastic

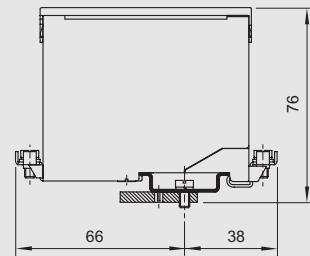

09933E00

Safety barriers 9001, 9002, 9004
mounting on
mounting plate by means of adaptor

We reserve the right to make alterations to the technical data, weights, dimensions, designs and products available without notice. The illustrations cannot be considered binding.

